



PLASMOTEC

Delivering the Complete Package

PLASTIC MOULDING TECHNOLOGY





DESIGN

- Concept
- Solid Modelling
- Prototypes
- Fill Simulation

TOOLMAKING

- 'In-house' Toolroom
- CAD/CAM
- Standard Tool Bases
- Low Cost Tooling Options

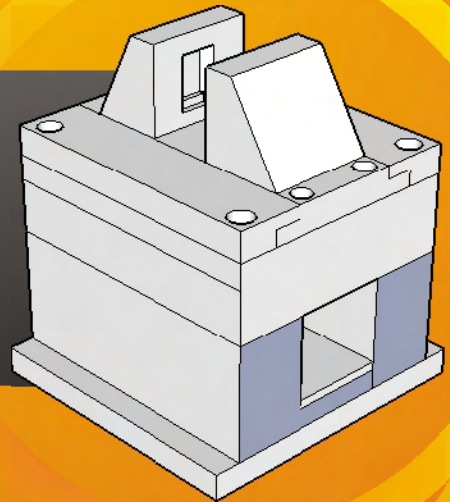

PRODUCTION

- Latest Machinery
- Real-time Monitoring
- Presses From 22 Tonnes
- ISO9001:2009

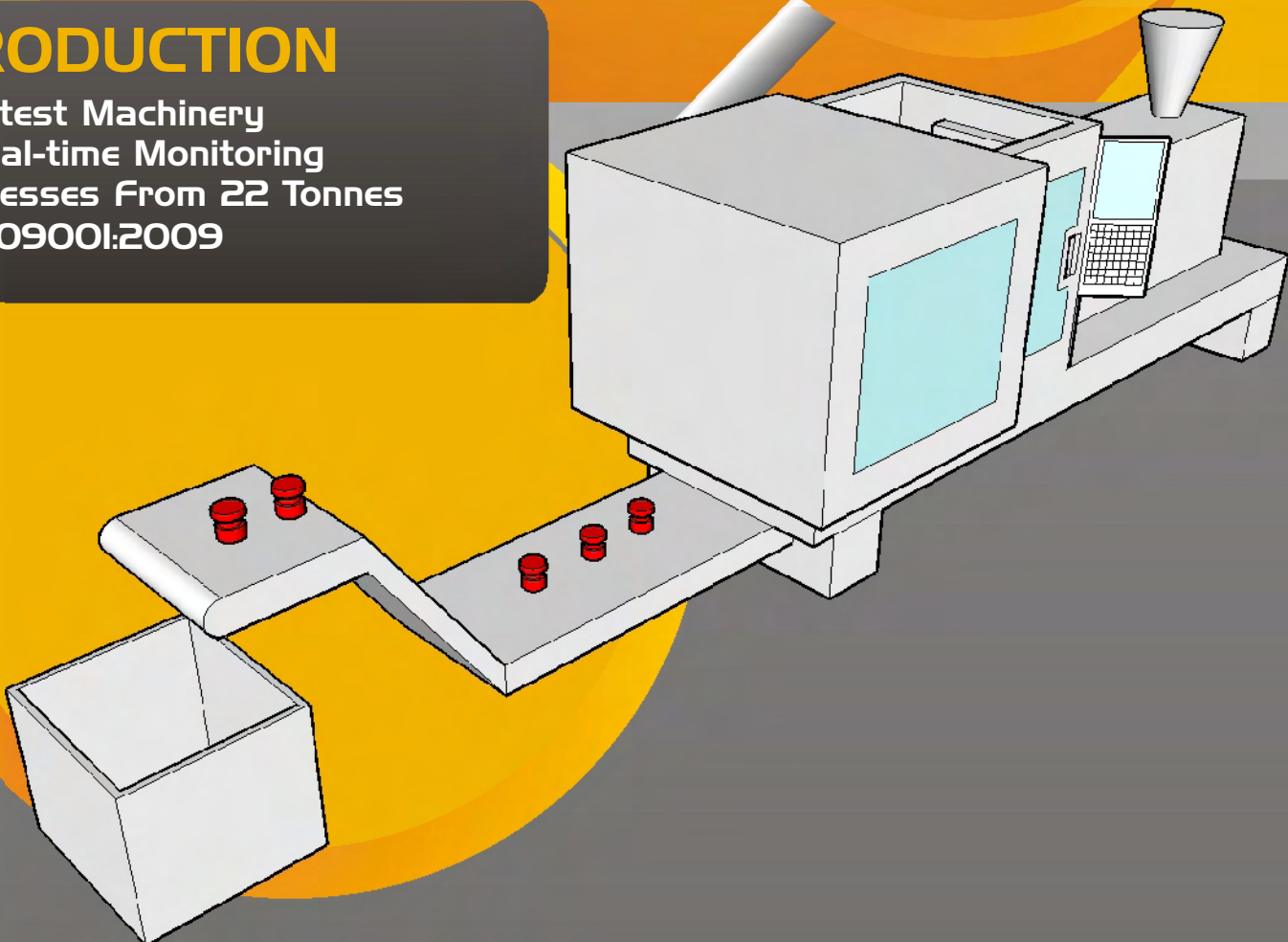

Delivering the Complete Package

ABOUT PLASMOTEC

- Established in 1989
- Private Company
- 24 Hour Production
- Custom Mouldings
- Standard Parts
- Total Project Management

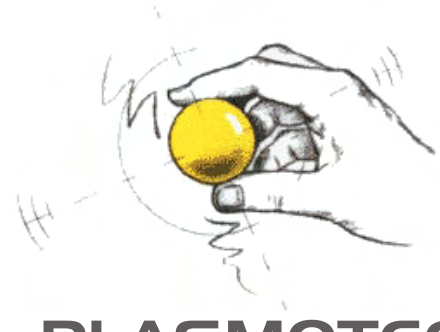

PLASMOTEC

ASSEMBLY

- Bespoke Fully Automatic Assembly
- Added Value Operations

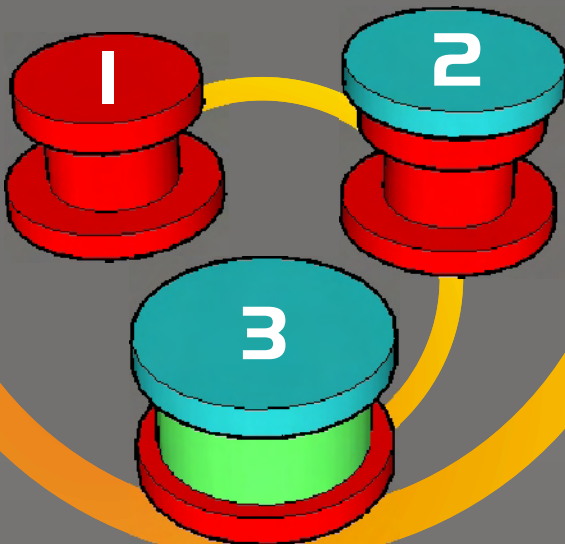

PRINT/PACKING

- Pad Printing
 - Automatic
 - Manual
- Custom Packing

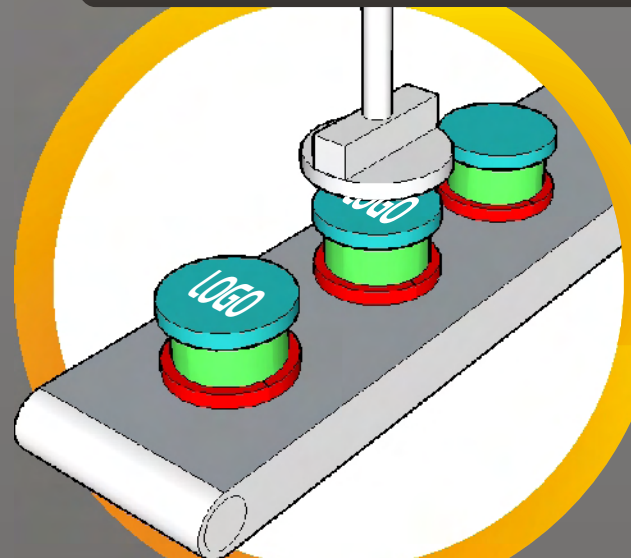

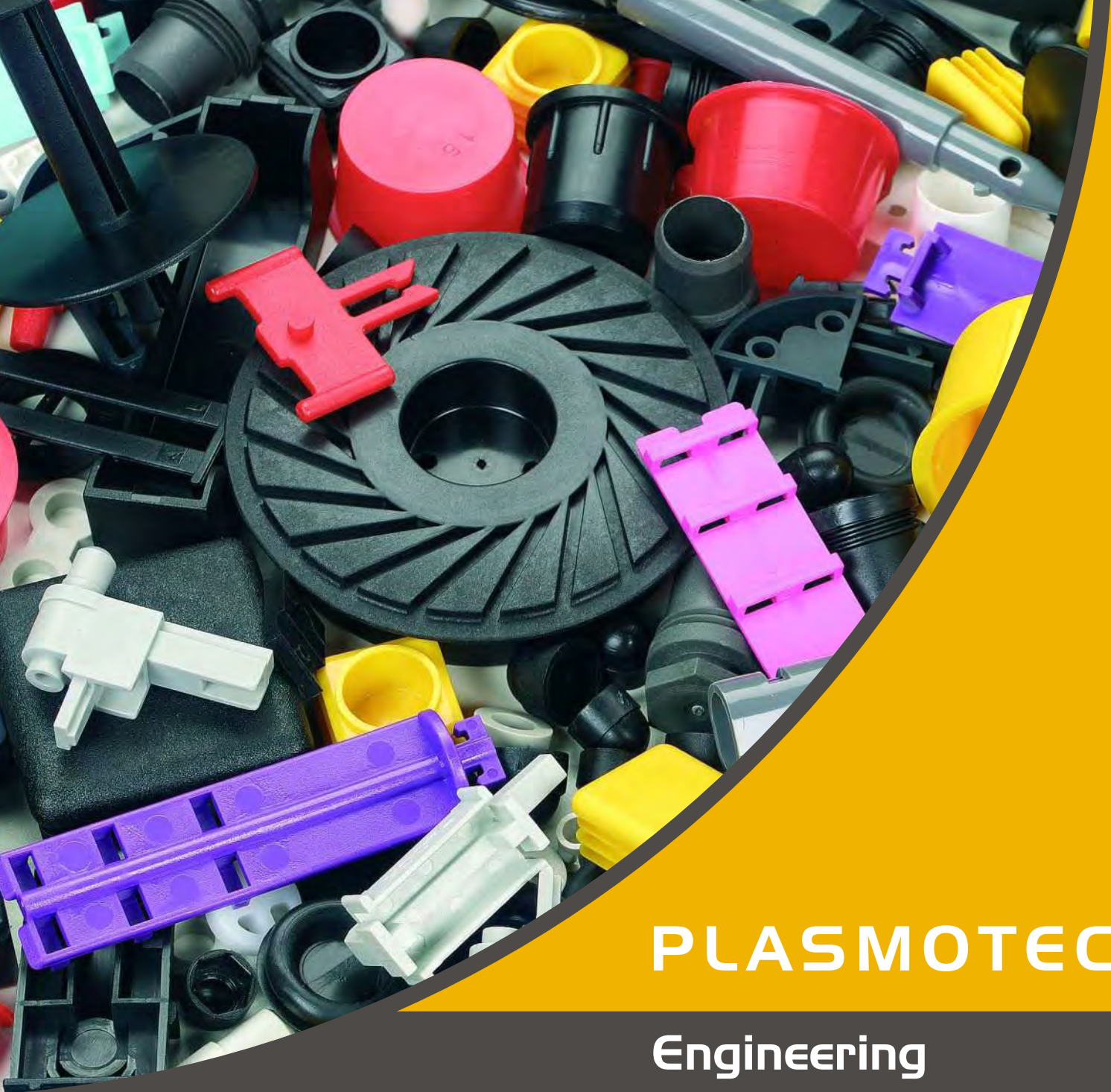

PLASMOTEC

Engineering

Plasmotec produces hundreds of custom parts and a range of standard parts for the Engineering industries.

Applications include products for:

- Display Systems/Point of Sale
- Automotive
- Electrical
- Gas/Fluid
- Protection Products
- Automated Equipment

Details of Standard Parts are available on our website:

www.plasmotec.co.uk

WARD ROAD, LINCOLN PARK
BUCKINGHAM ROAD INDUSTRIAL ESTATE
BRACKLEY, NORTHANTS
NN13 7LE

TEL: 01280 701335
FAX: 01280 701341
EMAIL: sales@plasmotec.co.uk
www.plasmotec.co.uk

SERVICES LIST

- Design
- Toolmaking
- Moulding
- Assembly
- Print
- Packaging

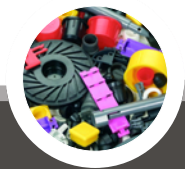

PLASMOTEC LIMITED

WARD ROAD, LINCOLN PARK
BUCKINGHAM ROAD INDUSTRIAL ESTATE
BRACKLEY, NORTHANTS
NN13 7LE

TEL: 01280 701335

FAX: 01280 701341

EMAIL: sales@plasmotec.co.uk

www.plasmotec.co.uk